

Matrix Meter

Used to dispense petroleum-based lubricants and antifreeze only.

Part No. 246008 Series D, North America (N. A.)

Part No. 249881 Series D, Australia

1500 psi (10.3 MPa, 103 bar) Maximum Working Pressure

600 psi (4.1 MPa, 41.4 bar) Maximum Dynamic Working Pressure (while dispensing)

5 gpm (18.9 lpm) Maximum Flow Rate



Important Safety Instructions

Read all warnings and instructions in this manual. Save these instructions.



CAUTION

This dispense valve is:

- Designed to dispense petroleum-based lubricants and antifreeze **ONLY**.
- Designed for indoor use **ONLY**.
- **NOT** designed for in-line installation.

The Matrix Meter contains an RF device with the following approvals:



FCC ID: JHIGNET
IC: 4840AGNET



Australian Vendor Code: N3845

Industry Canada Statement

The term "IC" before the certification/registration number only signifies that the Industry Canada technical specifications were met.

Contents

Manual Conventions	2	Troubleshooting	16
Warnings	3	Calculating the Calibration Factor	19
Programming the Meter	4	Service	21
Meter Programming	4	Replacing or Cleaning Filter	21
Meter Installation	6	Replacing Quick-lock™ Nozzle	21
Pressure Relief Procedure	8	Replacing the Bezel	22
Grounding	8	Replacing the Trigger	24
Pre-installation Procedure	8	Replacing the Meter Electronics	28
Installing Nozzle Extension	9	Parts Drawing for the 246008 and 249881	
Meter Installation to Hose	9	Electronic Meters	32
Pressurizing the System	9	Parts List for the 246008 and 249881	
Meter Operation	10	Electronic Meters	33
Asleep/Awake Mode	10	Nozzle Extension Accessories	34
High/Low Flow Rate Indicator	10	Kit 246005	34
Battery Life Indicator	10	Kit 246006	34
Security Modes	11	Kit 246007	34
Work Orders and Job Numbers	12	Technical Specifications	35
Dispense Options	14	Dimensions	37
Manual Dispense Mode	14	Graco Standard Warranty	38
Preset Dispense Mode	14	Graco Phone Numbers	38
Restricted Preset Dispense Mode	15		
Removing and Replacing the Battery	15		
Quick-Lock™ Nozzle	15		

Manual Conventions

WARNING

WARNING indicates a potentially hazardous situation which, if not avoided, could result in death or serious injury.

CAUTION





CAUTION indicates a potentially hazardous situation which, if not avoided, may result in property damage or destruction of equipment.

Note

A note indicates additional helpful information.

Warnings

The following warnings include general safety information for this equipment. More specific warnings are included in the text where appropriate.

 WARNING	
	<p>SKIN INJECTION HAZARD</p> <p>High-pressure fluid from dispense valve, hose leaks, or ruptured components will pierce skin. This may look like just a cut, but it is a serious injury that can result in amputation. Get immediate surgical treatment.</p> <ul style="list-style-type: none"> Do not point dispense valve at anyone or at any part of the body. Do not put your hand over the end of the dispense nozzle. Do not stop or deflect leaks with your hand, body, glove, or rag. Follow Pressure Relief Procedure in this manual, when you stop spraying and before cleaning, checking, or servicing equipment.
	<p>FIRE AND EXPLOSION HAZARD</p> <p>When flammable fluids are present in the work area, such as gasoline and windshield wiper fluid, be aware that flammable fumes can ignite or explode. To help prevent fire and explosion:</p> <ul style="list-style-type: none"> Use equipment only in well ventilated area. Eliminate all ignition sources, such as cigarettes and portable electric lamps. Keep work area free of debris, including rags and spilled or open containers of solvent and gasoline. Do not plug or unplug power cords or turn lights on or off when flammable fumes are present. Ground equipment. Use only grounded hoses. If there is static sparking or you feel a shock, stop operation immediately. Do not use equipment until you identify and correct the problem. Keep a fire extinguisher in the work area.
	<p>BATTERY SAFETY</p> <p>The battery may leak, explode, cause burns, or cause an explosion if mishandled:</p> <ul style="list-style-type: none"> You must use the battery type specified for use with the equipment. Sparking can occur when changing batteries. Only replace the battery in a non-hazardous location, away from flammable fluids or fumes. Handle and dispose of battery properly - do not short circuit, charge, force over discharge, disassemble, crush, penetrate, incinerate, or heat the battery to a temperature exceeding 185° F (85° C).
	<p>EQUIPMENT MISUSE HAZARD</p> <p>Misuse can cause death or serious injury.</p> <ul style="list-style-type: none"> Do not exceed the maximum working pressure or temperature rating of the lowest rated system component. See Technical Data in all equipment manuals. Use fluids and solvents that are compatible with equipment wetted parts. See Technical Data in all equipment manuals. Read fluid and solvent manufacturer's warnings. Check equipment daily. Repair or replace worn or damaged parts immediately. Do not alter or modify equipment. For professional use only. Use equipment only for its intended purpose. Call your Graco distributor for information. Route hoses and cables away from traffic areas, sharp edges, moving parts, and hot surfaces. Do not use hoses to pull equipment. Comply with all applicable safety regulations.

Programming the Meter

Graco recommends that meters be programmed **prior** to installation.

For ease of installation be sure to tag each meter with the corresponding PC meter number from the Matrix software. For example: Bay 1, 10W30. These tags are used for locating the corresponding meter in the assigned bay or location.

 The electronic meter batteries need to be charged prior to use. See *Instruction Manual 309502* for details.

Meter Programming

 Prior to programming the electronic meters,

- Enter the transceiver and tank setup information into the Matrix PC software. If not done, the software will display an error when attempting to set up meters.
- Navigate to the Meter Setup screen, input the meter parameters, then select PROGRAM for the meter being programmed.

1. Insert the battery. See **Removing and Replacing the Battery** on page 15.
2. When the battery is first inserted, the display shown in FIG. 2 appears.
3. To program a meter, simultaneously hold down both the left keypad button (A) and right keypad button (B) until both the ACTIVATE words on the display screen change to PROGRAM (appears on the left) and SELECT (appears on the right). Release buttons.

4. The screen indicates a Network and Transceiver ID. See FIG. 1.

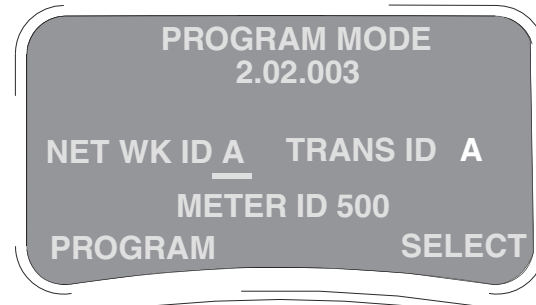





FIG. 1

- If the ID information is correct, press the left (A) keypad button labeled PROGRAM to complete the meter programming.
- If the ID information is incorrect, use the SELECT button and up/down arrow button to obtain the correct ID settings. Then press the left (A) keypad button labeled PROGRAM to complete the meter programming. See FIG. 2.

 The meter must be at the ACTIVATE/ACTIVATE screen for it to be programmed. If you are in Work Order mode, put a test Work Order into the system so you can navigate to the ACTIVATE/ACTIVATE meter screen and re-program.

 METER ID is the RF address assigned to the meter by the PC during programming.

- The meter displays the appropriate programmed screen and a pop-up window displays on the PC indicating programming is complete. This process is repeated for each meter in the system.

 The PC software allows a 5 minute period to program the meter.

 If the electronic meter is unable to communicate with the PC during programming, the message NO SIGNAL appears at the top of the meter display.

- Once the information is programmed into the electronic meter, the meter can be connected to the dispensing hose in the corresponding bay. If the meter will not be immediately connected temporarily label it with the corresponding meter number and location (i.e. Meter 1, Bay 1, 10W30). The label assures the correct meter is installed in the correct location in the system. After the meter is installed in the correct location, the label can be removed. See **Meter Installation** on page 6.

 If a programmed meter is moved or if the programmed parameters need to be changed, the meter must be reprogrammed.

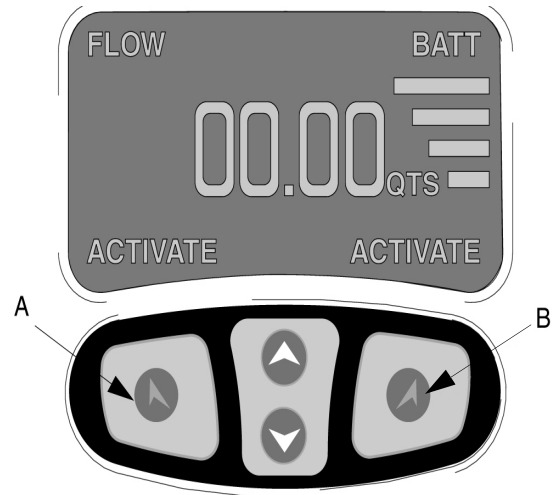



FIG 2

 If PC software revision is 2.01.29 or meter firmware revision is 2.00.053, meter will display 3 places to the right of the decimal rather than 2.

Meter Installation

CAUTION

Failure to comply with the following installation requirements may result in warranty coverage being denied.

- Fluid lines **MUST** be thoroughly flushed before installing Matrix meters. See CleanLine Filtration System, Instruction Manual 310652.
- All Matrix systems **MUST** use the Graco Clean-Line System for initial flushing and ongoing operation for all service fluids. See CleanLine Filtration System, Instruction Manual 310652.
- Pressure relief kits **MUST** be used on all pumps within the Matrix system to prevent over-pressurization due to thermal expansion. See Pressure Relief Kits, Instruction Manual 308403. Select appropriate relief kits when using high pressure (1600 psi) CleanLine filters. **Low pressure (900 psi) CleanLine filters have a built-in pressure relief valve.**

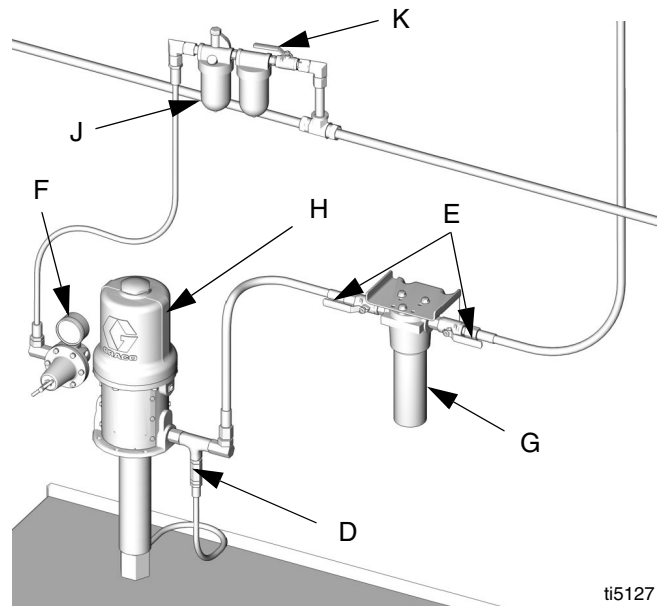

FIG. 3

ti5127

KEY	DESCRIPTION, See FIG. 3.
D	Thermal Pressure Relief Kit must be installed downstream from the pump. The Thermal Pressure Relief Kit will vary based on the pump selected
E	Fluid shut-off valves (two)
F	Air Regulator
G	CleanLine Filter System
H	Pump * †
J	Filter and Lubricator Assembly
K	Master Bleed Air Valve (ball valve)

* Do not use diaphragm pumps in a Matrix system.

† Special pump packages are required for anti-freeze. See instruction manual 310650.

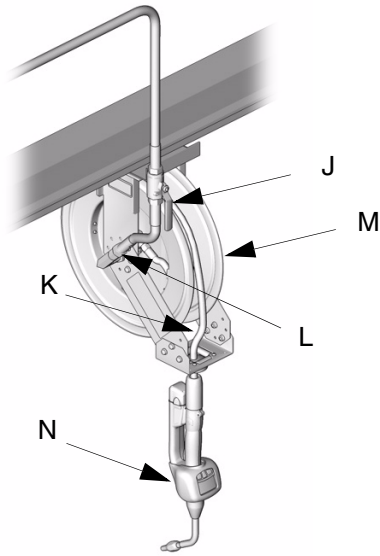

FIG. 4

KEY	DESCRIPTION, See FIG. 4.
J	Fluid shut-off valve
K	Hose
L	Hose reel fluid inlet hose
M	Hose reel
N	Electronic metered dispense valve

Mounting Brackets

Mounting bracket kit 249440 is available for resting a Matrix meter on a console. See FIG. 5.

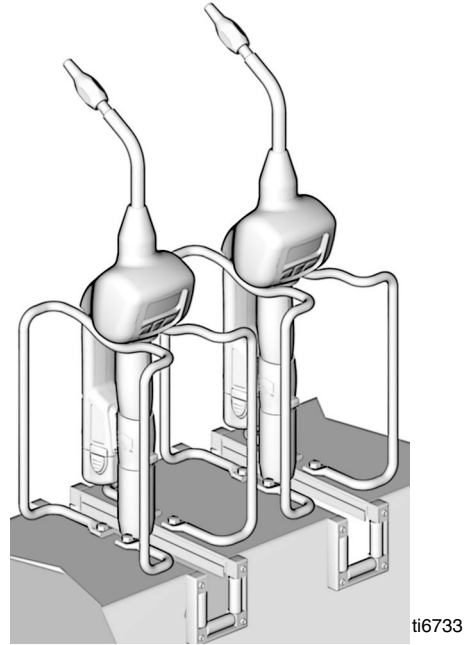

FIG. 5

Mounting bracket 15B750 is available for resting a Matrix meter on a 16 gallon drum. See FIG. 6.

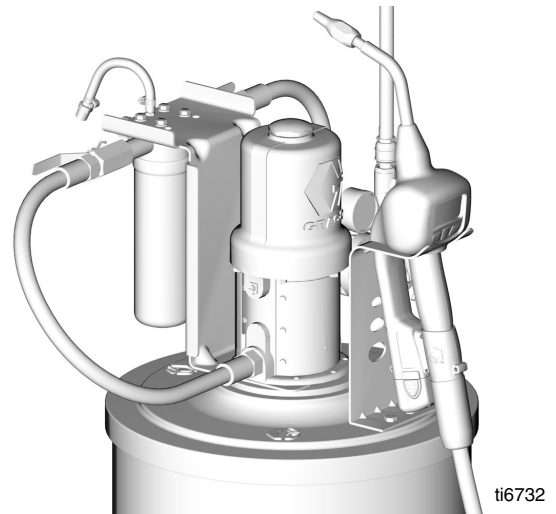





FIG. 6

Pressure Relief Procedure

 **WARNING**

 



Read warnings, page 3, and follow the **Pressure Relief Procedure** whenever you:

- are instructed to relieve pressure
- stop operation
- check, clean, or service any of the equipment

1. Turn off the power supply to the pump.
2. Trigger the dispense valve into a waste container to relieve pressure.
3. Open any bleed-type master air valves and fluid drain valves in the system.
 The Matrix meter must be powered, nozzle open (counter clockwise), and in dispense mode for fluid pressure to be relieved.
4. Leave the drain valve open until you are ready to pressurize the system.

Grounding

 **WARNING**

The system must be properly grounded. Read warnings, page 3. Refer to the user manuals for the pump and other system components, and ground the following:

- *Pump:* Follow the manufacturer's recommendations.
- *Air and Fluid hoses:* Use only grounded hoses.
- *Air compressor:* Follow the manufacturer's recommendations.
- *Fluid supply container:* Follow the local code.
- *To maintain grounding continuity when flushing or relieving pressure,* always hold a metal part of the valve firmly to the side of a grounded metal pail, then trigger the valve.

Pre-installation Procedure

1. **Relieve the pressure.** Follow the **Pressure Relief Procedure** on page 8.
2. Close the shut-off valve (J). See FIG. 4.
3. Ground the hose and reel or console. See **Grounding**.
4. If this is a new installation or if the fluid in the lines is contaminated, flush the lines before you install the metered valve.

CAUTION

Contaminated lines could cause the valve to leak. Failure to flush may result in warranty coverage being denied. See CleanLine Filtration System, Instruction Manual 310652.

Installing Nozzle Extension

1. Slide the impact guard (40) onto the tube or hose of the nozzle extension assembly. See FIG. 7.
2. Thread the sealing nut (101, 204, or 303) onto the spout (102, 202, or 302).
3. Thread the tube or hose in at least three full turns, position it for proper alignment, and wrench tighten the sealing nut. The PTFE seal on the sealing nut must face the valve housing. See FIG. 7.
4. Slide the impact guard (40) over the meter body.

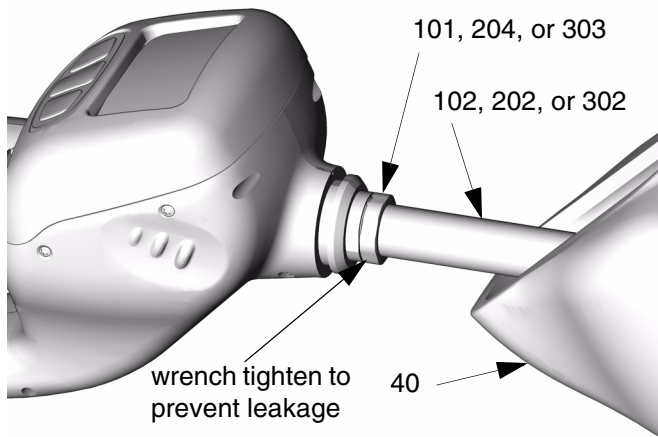

FIG. 7

Meter Installation to Hose

1. Slide the rear boot (24) onto the hose. See FIG. 8.

⚠ WARNING

Improper grounding can cause a hazardous condition and result in fire or explosion. Follow instructions in step 2 to maintain grounding continuity.

CAUTION

Graco recommends using PTFE tape on hose threads prior to installing the Matrix meter. PTFE tape should be after the leading thread and clockwise (same direction as meter installs on hose fitting). Caution should be taken not to get tape into the meter during installation as this can cause the meter to malfunction. Should the tape be the cause of the malfunction, Graco warranty will be denied.

2. Apply PTFE tape to the male threads of the hose fitting (P). **See caution above.** Leave a minimum of two engaged threads bare to maintain grounding continuity.

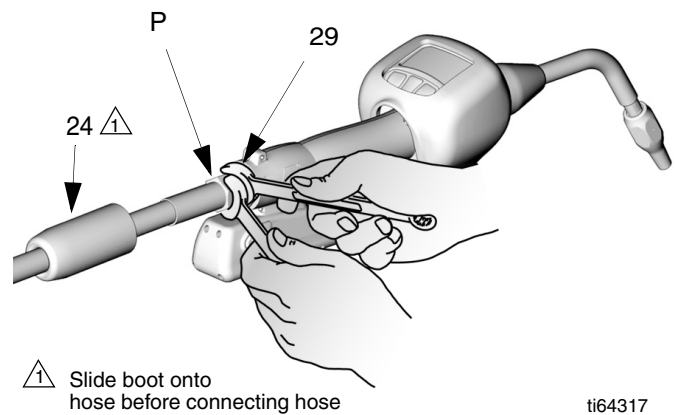

FIG. 8

3. Thread the hose fitting into the swivel (29) of the meter, and tighten it firmly. See FIG. 8.
4. Slide the rear boot (24) over the fittings and onto the end of the Matrix meter.

Pressurizing the System

1. Open all dispense position shut-off valves. Start the pump to pressurize the system. See the **Operation** section, page 14, for proper operation of meter.
2. To ensure dispensing accuracy, purge all air from the fluid lines and dispense valve before using it.
3. Set the system flow to the desired flow rate, which is typically 1.5-gpm. Do not exceed a 5-gpm flow rate.

Meter Operation

Asleep / Awake Mode

Asleep is a battery-saving mode in which the display goes blank after two minutes of inactivity during normal operation. The display comes *Awake* from sleep mode when any button is pressed.

High/Low Flow Rate Indicator

The electronic meter dispenses fluids at two different rates.

As the trigger is partially engaged, the flow rate is low and is indicated by two bars on the display. See FIG. 9.

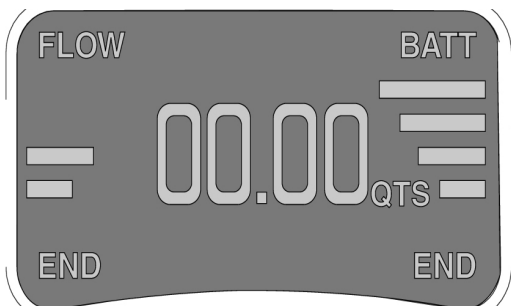

FIG. 9

- When the trigger is fully engaged, the flow rate is high and is indicated by four bars on the display. See FIG. 10.

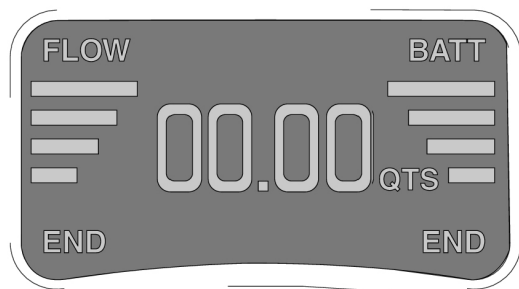

FIG. 10

Battery Life Indicator

On the right side of the display is a series of four bars located under the word BATT. See FIG. 11. The presence of all four bars indicates a fully charged battery. The bars decline in number as the meter is used and the battery discharges. All Matrix meter batteries should be re-charged at the end of the working day to assure good performance the next work day.

- Batteries can be recharged at anytime without battery damage.
- At one bar on the display you will have about 20-40% of the charge remaining.
- If a meter is removed from service for an extended time the battery should be removed and recharged.
- If you see the message "Remove Low Battery - Wait 30 Seconds Then Replace", remove the battery, wait 30 seconds, and then replace it with a charged battery.
- Even when a meter is idle (asleep), the meter is still functioning and the battery will be used.

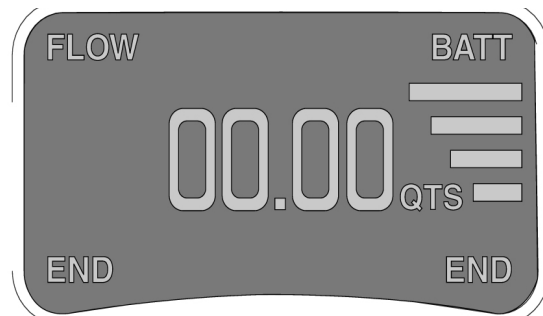

FIG. 11

Security Modes

When the meters were originally programmed by the system administrator, one of the following security choices was entered:

- System Monitoring
- PIN Code
- Parts Room Authorization

Prior to dispensing, it may be necessary to complete one of the following security procedures, depending on the security mode selected.

System Monitoring

When set for system monitoring, no security authorization is required by the operator. However, any amount of fluid dispensed is automatically sent by the meter to the PC where it is recorded for future reference.

PIN Code

PIN Code (personal identification number) means that a four digit PIN code must be entered at the meter to obtain dispense authorization. To use a meter with PIN code security:

1. Use the up and down arrow keypad buttons to select the first number of the PIN code.
2. Press the right keypad button to move the cursor to the next position.
3. Use the up and down keypad buttons to select the desired number. Continue this process until the PIN code number is completed. See FIG. 12.

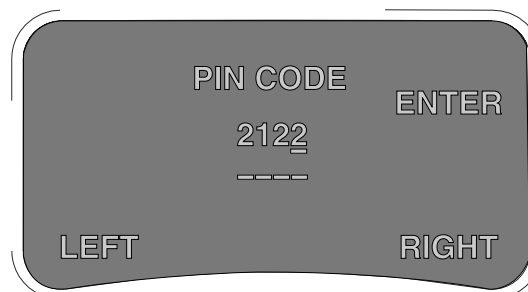

FIG. 12

4. When the pin code is complete, press the right keypad button until the cursor underlines the Enter option. Press the up arrow on the meter keypad. This action will enter the PIN code and send it to the PC.
5. The PC recognizes the PIN code and authorizes the meter to dispense.

Parts Room Authorization

This mode provides high level security and requires a Parts Room Administrator to authorize each dispense.

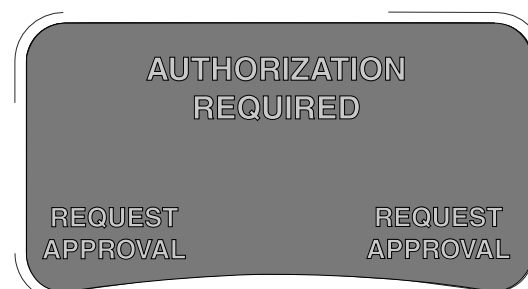

FIG. 13

1. Press either the left keypad or right keypad button under REQUEST APPROVAL. This sends the request to the parts room administrator's PC for dispense authorization. See FIG. 13.
2. The administrator grants authorization at the PC, which then authorizes the meter to dispense.

Work Orders and Job Numbers

When the meters were programmed by the System Administrator, one of the two Work Order processing methods below was selected.

- Work Order/Job Number at the PC only
- Work Order/Job Number at the PC and Meter

Work Orders are a maximum of (12) characters and the Job Number is a maximum of (3) characters. The Work Order number is separated from the Job Number with a dash (-).

The characters A-Z, 0-9, dash (-); forward slash (/), period (.), or space can be used when assigning a Work Order or Job Number. One Work Order can have more than one service using an extension in the order number (i.e., 123456.oil, 123456.atf). The meter can receive up to five (5) work orders at a time. See FIG. 14.

Assigning Work Orders and Job Numbers from the PC

Work Orders and Job Numbers are assigned to a meter from the PC using the “Entering Work Orders” button in the software. This feature is password protected.

1. Click on the **Entering Work Orders** button. Type in the user name and password and click **Submit**.
2. Click on the **Add Work Order** box. Select meter from the pull down screen. Type in a Work Order (up to 12 characters). Tab or mouse click to the Job Number box and enter the Job Number (up to 3 characters) if desired, then click **Send**.
3. If the Work Order is received by the designated meter, the PC Work Order list will be updated to show “Dispense Pending” in the status column.

If the Work Order is not received by the meter, a pop-up box appears indicating that the Work Order could not be sent to the assigned meter. You then can click Retry or Cancel.

Assigning Work Orders and Job Numbers at the Meter

Work Orders and Job Numbers can be assigned at the meter using the meter Work Order screen and meter keypad buttons. The screen shows previously assigned Work Orders and the **Enter New** option.

To enter a new Work Order follow the procedure below:

1. At the **Work Order/Job Number meter screen**, select the **Enter New** option using the up and down keypad buttons. When the arrow is positioned prior to the **Enter New** option, push either one of the two outside keypad buttons to **Select** the option. This will take you to a second screen to enter the Work Order/Job Number. Matrix meters can display up to 5 work orders and the Enter New command. See FIG. 14.

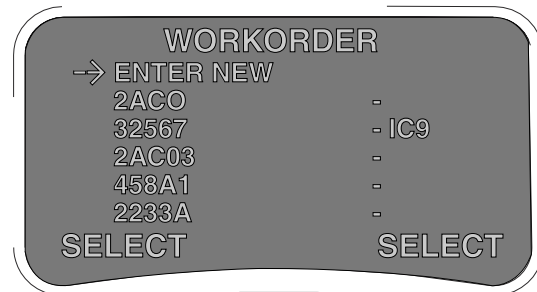

FIG. 14

2. On the second Work Order/Job Number screen, the cursor defaults to the first character position for entering the Work Order (up to 12 characters). Use the up and down keypad buttons to select a number, letter, or character for the first digit of the Work Order.
3. Press the right keypad button to move the cursor to the next character position. Use the arrow keypad buttons to select the character desired. Continue this process until the Work Order is completed. See FIG. 15.

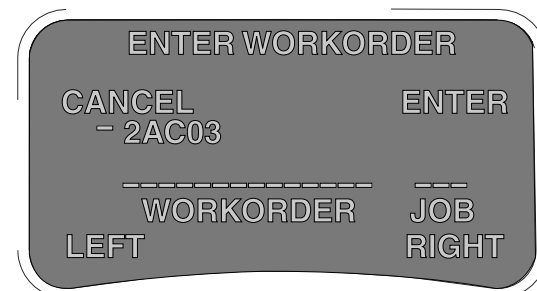



FIG. 15

4. Press the right keypad button and navigate to the first position to enter the Job Number if desired. Enter the Job Number in the same manner as you entered the Work Order number.

- When the numbers are complete, press the right keypad button until the cursor underlines the **Enter** option. Press the **up arrow** on the meter keypad display. This action will enter the new Work Order to the list on the first screen.

 To **Cancel** a Work Order press either the right or left keypad button on the meter until the cursor underlines the **Cancel** option. Push the up arrow on the keypad to cancel the Work Order entry. This will take you back to the first Work Order/Job Number screen.

Work Order Validation Mode: The default operation mode for either work order method is validation mode. This mode is recommended for maximum protection against unauthorized dispenses and maximum integrity of the Matrix database.

Emergency Mode

If the communication link is lost (power loss, computer crash), the meters will continue to function if they are placed in the Emergency Mode.

 During Emergency Mode, the meter continues to store dispense history and will communicate this information to the PC when the communication link is restored.

Placing a Meter in the Emergency Mode

The Emergency Code Number must be provided by the system administrator before performing this procedure.

- Select the meter(s) to place in the Emergency Mode.
- Simultaneously hold down both the left and right keypad buttons until **ACTIVATE** appears in the lower left and right corners of the meter display.
- Press the **UP** arrow keypad button once which takes you to the Emergency Mode screen.
- Enter the four-digit Emergency Code Number. Position the cursor under the word **ENTER** and press the **UP** arrow on the keypad. Meter security is bypassed and the meter is now in the Emergency Mode. This procedure must be repeated for each meter placed into the Emergency Mode.
- When communication is restored, each meter placed into Emergency Mode **must be re-programmed** with its original settings.

 After the meter is placed in Emergency Mode, the battery must remain in the meter until the display goes blank. If not, the meter will revert to its original programming.

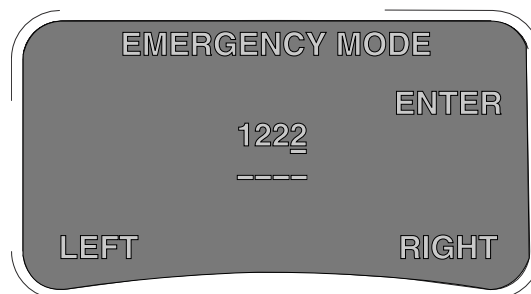

FIG. 16

Dispense Options

The meter dispense options are determined by the system administrator at the time the meter is programmed. Meter dispense options include:

- Manual Dispense Mode
- Preset Dispense Mode
- Restricted Preset Dispense Mode



To change the meter from one mode to another, you must reprogram the meter. See **Programming the Meter** on page 4.

Manual Dispense Mode

To dispense fluids in this mode:

1. If necessary, enter the PIN code, Parts Room Authorization request and/or the Work Order request.
2. Press the left or right keypad button under ACTIVATE to begin communication with the PC. Both ACTIVATE words on the display screen will change to END.
3. Pull the meter trigger to dispense. The meter counts up to the desired amount.
4. Release the trigger when the desired amount is obtained. Then press the right or left keypad button to end the dispense. This logs the dispense amount to the PC and returns the meter to its programmed entry screen.



If END is not pressed, after five minutes the meter will automatically end the job and log the dispense to the PC.

Once the preset amount is dispensed, the meter display automatically changes to read TOP OFF MODE. This allows the operator to add additional fluid after the preset amount is dispensed. The Top Off amount to be dispensed can be limited during meter programming. See FIG. 18.

Preset Dispense Mode

Meters programmed in preset mode count down from a specified value to zero and shut off automatically. The preset value can be increased or decreased from the initial value using the up and down keypad buttons.

1. If necessary, enter the PIN code, Parts Room Authorization request and/or work order request.
2. Press ACTIVATE to enter the dispense mode. The preset default amount entered into the PC will appear on the meter. See FIG. 17.



FIG. 17

3. If desired press the arrow up or arrow down keypad button to change the preset amount.

OR

4. Press the right keypad button under the word CLEAR to zero out the preset amount. The arrow up and arrow down keypad buttons are used to enter a new amount of fluid to dispense.
5. Pull and release the meter trigger to start the dispense. The meter dispenses the preset amount and shuts off.

Flow can be stopped at any time during the dispense by pressing the meter trigger or any button on the meter display.



An appropriate preset amount can be set for each work order when entering work orders at the PC.



FIG. 18

- If the operator wants to top-off fluids, press the left arrow key to display the TOP-OFF MODE. See FIG. 19.



FIG. 19

- Pull the trigger to dispense the desired fluid amount for top-off.
- Press END to complete the job. See FIG. 19. This logs the dispense to the PC and returns the meter to its programmed entry screen.

If END is not pressed, after 5 minutes the meter will time out and log the dispense to the PC.

Restricted Preset Dispense Mode

When meters are programmed in restricted preset mode, the specified dispense value cannot be increased, only decreased. The functionality of this feature is identical to Preset Dispense Mode (see **Preset Dispense Mode** beginning on page 14) except that the preset value can only be decreased with the down keypad button.

Removing and Replacing the Battery

- Remove the battery by pressing in on both battery lock buttons (E) and pulling the battery (F) out and away from the meter. See FIG. 20.
- Place the battery in the battery charger. See *Instruction Manual 309502* for details.
- Replace the battery by pressing in on both battery lock buttons (E) and pushing the battery (F) into the meter.

If the meter displays a low battery warning, wait 30 seconds before installing a new battery. See Battery Life Indicator page 10.

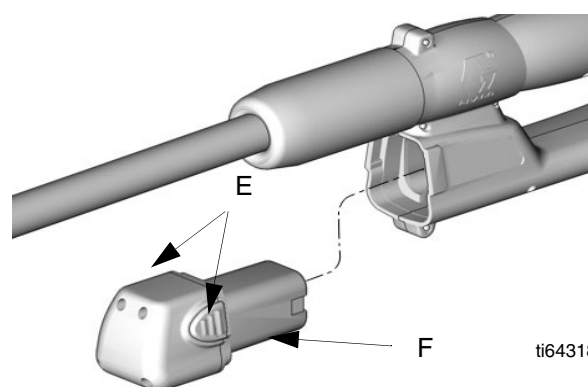

FIG. 20

Quick-Lock™ Nozzle

The nozzle opens and closes with LESS THAN one turn.

- To close the nozzle to prevent dripping, rotate left (counter clockwise) until tight. See FIG. 21.
- To open the nozzle for dispensing, rotate right (clockwise) until fully open.

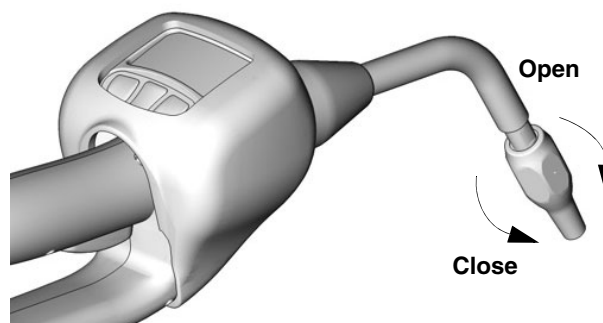

FIG. 21

Troubleshooting

WARNING



Read warnings, page 3.

Relieve pressure before you check or repair the meter. Follow the **Pressure Relief Procedure**, page 8. Be sure all other valves and controls and the pump are operating properly. If using the chart below to troubleshoot is not successful, contact your Graco distributor for repairs or component replacement.

Problem	Cause	Solution
Battery display bars do not appear.	Battery has low charge.	Recharge battery.
Meter display does not activate.	Battery is dead.	Attempt to recharge a dead battery using procedures outlined in the Battery Charger Instruction Manual (309502). If procedure does not restore a normal charge, replace the battery.
	Battery inserted too soon.	Wait 30 seconds and reinstall fully charged battery.
	Cable connections are loose or disconnected.	Ensure cables are properly connected. See page 22.
	Electronic display is damaged.	Replace with Bezel Repair Kit (246438). See page 33.
Slow or no fluid flow from meter.	CleanLine filter system is clogged.	Clean or replace the CleanLine filter. Refer to the CleanLine Filter System Instruction Manual (310652).
	Meter is not in dispense mode.	See dispense options, page 14.
	Matrix meter filter is clogged.	Clean or replace the Matrix meter filter element. See Cleaning or Replacing the Filter page 21.
	Pump pressure is low.	Turn up air pressure to the pump. See Technical Specifications page 35.
	Pump or reel fluid shut-off valve is not fully open.	Fully open pump or reel fluid shut-off valve.
	Meter hydraulic valve is not functioning.	If meter bars are lit indicating flow, the nozzle tip is fully open, and the fluid flow has been verified to the meter valve inlet, then the meter hydraulic valve has failed and the meter should be replaced.
	Electronic board connections may be loose or disconnected.	Verify that all connectors are connected or re-seated to the board connections. See page 22.
	Trigger membrane switch is damaged - flow bars DO NOT show on the meter display when the trigger IS actuated.	Replace the trigger membrane using the Trigger Repair Kit (246439 N. A., 249883 Australia). See page 33.
	Meter valve is blocked with debris - flow bars DO show on the meter display when trigger IS actuated.	Flush the valve with mineral spirits at high pressure and flow. Warning: do not exceed the maximum working pressure of the meter (1500psi - 103 bar).
	Quick close nozzle is closed.	Open nozzle, see FIG. 21 on page 15.
A hydraulic quick disconnect was used to connect the meter to the dispense hose, allowing debris to clog meter.	Quick disconnects should not be used with Matrix product, doing so voids the warranty.	

Problem	Cause	Solution
Meter does not stop dispensing.	Meter valve is blocked with debris - flow bars DO NOT show on the meter display when the trigger IS NOT actuated.	Flush the valve with mineral spirits at high pressure and flow. Warning: Do not exceed the maximum working pressure of the meter (1500 psi - 103 bar). If flushing does not resolve the problem, the meter should be replaced.
	Trigger or trigger membrane switch is damaged - flow bars DO show on the meter display when the trigger IS NOT actuated.	Replace the trigger and trigger membrane using the Trigger Repair Kit (246439 N. A., 249883 Australia). See page 33. Do not use clamps or wire ties to hold trigger during dispense, doing so voids the warranty.
	Dynamic System Pressure (while dispensing) exceeds the recommended 600 psi (4.1 MPa, 41.4 bar).	Reduce system pressure. A lower ratio pump may be required to reduce pressure and maintain sufficient flow.
	A hydraulic quick disconnect was used to connect the meter to the dispense hose, allowing debris to block meter.	Do not use quick disconnects with Matrix product. Use of quick disconnects voids the warranty.
Displayed dispensed amount is not accurate.	Meter is not programmed for the correct fluid type.	Verify meter programming.
	Meter gears are worn.	Meter requires calibration due to wear. See page 19.
Meter will not take work orders.	Battery has low charge or is dead.	Recharge battery.
	Battery inserted too soon.	Wait 30 seconds and reinstall fully charged battery.
	Meter may not be programmed.	Reprogram meter.
	Battery may have been pulled during programming.	Reprogram meter.
	Two meters may be programmed as the same meter.	Ensure each meter is programmed individually.
	Meter work order list is full.	Normal operation. Meter will hold up to 5 work orders.
Meter has intermittent or no RF communication.	Meter is outside RF communication range of transceiver.	Reposition transceiver or add a transceiver.
	Two meters may be programmed as the same meter.	Ensure each meter is programmed individually.
	PC or transceiver is off.	Turn PC on, open Matrix application, and check power on transceiver.
Meter will not program.	Incorrect COM port selected for transceiver connection.	Change to correct COM port at the PC in Matrix transceiver configuration screen.
	Transceiver is not powered up.	Power up transceiver, wait 30 seconds or until red lights go blank and green light remains on alone.
	Transceiver dip switches are not set for the communication cable being used.	See transceiver manual 309498 to set dip switches.
	Matrix program is not in programming mode.	Place PC in programming mode. See Programming the Meter, page 4.
	The five-minute programming session has expired.	Place PC in programming mode. See Programming the Meter, page 4.
	Network and transceiver settings on the meter are not correctly set.	Make appropriate settings. See Programming the Meter, page 4.
	Meter is outside RF communication range of transceiver.	Reposition transceiver or add a transceiver.

Problem	Cause	Solution
Meter has been in service for an extended period of time and begins to work erratically such as loss of Work Orders or Security settings.	E-Prom on meter board has reached the end of its life.	Attempt to reprogram the meter. If you see a pop-up screen on the PC that says, "Memory Failure" and/or the meter screen defaults to the ACTIVATE/ACTIVATE screen, the E-Prom on the meter board must be changed. Install the Electronics Repair Kit (246675). The Electronics Repair Kit includes a new meter board with E-Prom. The meter then can be reprogrammed to the features desired.
Meter leaks.	Extension may be loose from meter fluid housing.	Tighten seal nut using two wrenches.
	Swivel connection at hose may be leaking.	Clean, seal, and tighten joint.
Meter cuts on and off during preset dispense.	The trigger is being held during pre-set dispense.	Release the trigger during preset dispense.
	Trigger or trigger membrane switch is damaged - flow bars DO show on the meter display when the trigger IS NOT actuated.	Replace the trigger and trigger membrane using the Trigger Repair Kit (246439 N. A., 249883 Australia). See page 33. Do not use clamps or wire ties to hold trigger during dispense, doing so voids the warranty.
Meter displays "active trig"	Trigger or trigger membrane switch is damaged - flow bars DO show on the meter display when the trigger IS NOT actuated.	Replace the trigger and trigger membrane using the Trigger Repair Kit (246439). See page 33. Do not use clamps or wire ties to hold trigger during dispense, doing so voids the warranty.
	Trigger is being held before activating meter for dispense.	Release trigger to activate meter.

* To use the Matrix Emergency Mode contact the Matrix System Administrator in your facility.

Calculating the Calibration Factor

Use the following tables and formulas to calculate the change to the calibration factor.

Example of Calibration Adjustment for Motor Oil (quarts - 368)

Dispense into a clean, calibrated, volumetric measuring flask until the meter display indicates 1 quart of fluid has been dispensed.



For greater accuracy, submerge the nozzle and let the air settle out of the fluid for ten minutes before noting the volume.

- In the following example, the flask shows the volume is less than one quart (-1.2 ounces). See the left column and find the number closest to -1.2 ounce value which is 1.0.
- Look for the corresponding number in the right column, which is +12. If the current calibration factor is 368, add 12 to get the new calibration factor of 380.
- Change this factor for a fluid in Tank Setup and for given meter(s) in Meter Setup.

Metric Measurement Measuring in liters, and 1 liter is dispensed	
Error in Milliliters (ml)	Change Calibration Factor by:
+ 50	- 20
+ 40	- 16
+ 30	- 12
+ 20	- 8
+ 10	- 4
+ 0	no change
- 10	+ 4
- 20	+ 8
- 30	+ 12
- 40	+ 16
- 50	+ 20

U.S. Measurement Measuring in quarts, and 1 quart is dispensed	
Error in U.S. ounces (oz.)	Change Calibration Factor by:
+ 1.7	- 20
+ 1.4	- 16
+ 1.0	- 12
+ 0.68	- 8
+ 0.34	- 4
0	no change
- 0.34	+ 4
- 0.68	+ 8
- 1.0	+ 12
- 1.4	+ 16
- 1.7	+ 20

The table on the right lists approximate calibration factors for different fluids. Your calibration number may vary slightly due to temperature or flow rate.

Fluid	Calibration Number	
	Quarts	Liters
Oil (10W-30)	368	389
Gear Lube	375	396
Automatic Transmission Fluid	368	389
Antifreeze	348	368



A series of horizontal lines for writing, consisting of 20 evenly spaced lines extending across the width of the page.

Service

WARNING



Read warnings, page 3.

Follow the **Pressure Relief Procedure**, page 8, whenever you:

- are instructed to relieve pressure
- stop operation
- check, clean, or service any of the equipment

The low-battery and dead-battery displays are explained in the **Troubleshooting** chart on page 16.

To change the battery see **Removing and Replacing the Battery** on page 15.

Replacing or Cleaning Filter

To replace or clean the filter, do the following:

1. **Relieve the pressure.**
2. Unscrew the hose from the swivel (29). See FIG. 22.
3. Remove the o-ring (6), and remove the filter (9) from its seat in the swivel (29) with an o-ring pick.
4. Thoroughly clean the filter with solvent, or replace with the new filter.
5. Push the new or cleaned filter (9) into the swivel (29), and make sure it's properly seated. Replace the o-ring (6).

 Be sure to position the new filter (9) so the concave side of the screen points downstream. See FIG. 22.

6. Screw the hose back into the swivel (29).

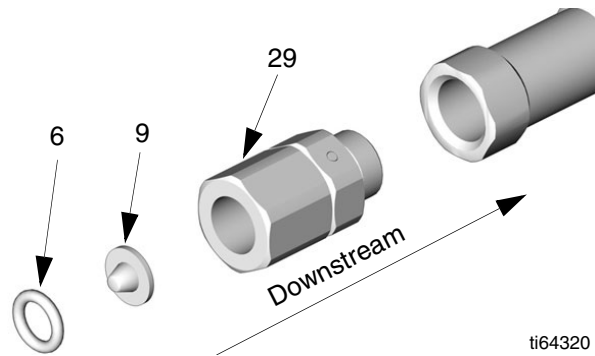

FIG. 22

Replacing Quick-lock™ Nozzle

The quick-lock nozzle (101, 201, or 301) is not serviceable. If the nozzle leaks, replace it as follows. See FIG. 23.

1. Remove the old nozzle from the extension with an open-end adjustable wrench on the flats (A) of the nozzle stem.
2. Thread the new nozzle (101, 201, or 301) onto the extension. With an open-end adjustable wrench on the flats (A) of the nozzle stem, firmly tighten the nozzle.

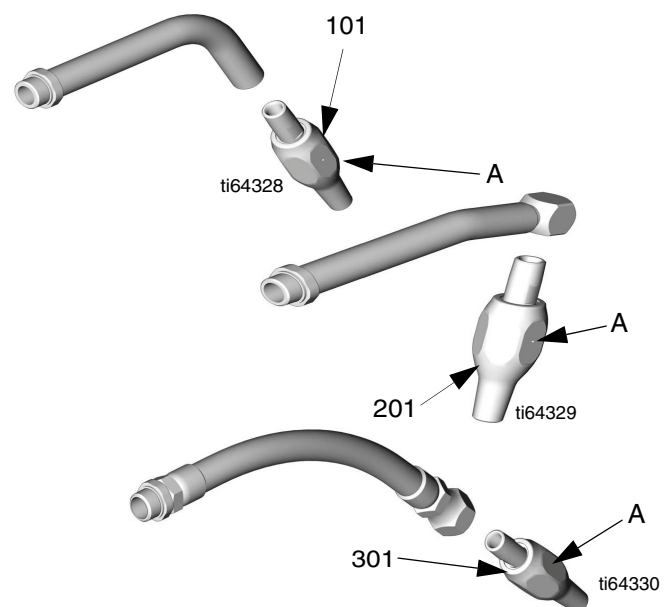

FIG. 23

Replacing the Bezel

Bezel Repair Kit 246438 is available and can be ordered separately. See the **Parts List for the 246008 and 249881 Electronic Meters** on page 33. The parts with a ★ next to their reference numbers are included in this repair kit.

When repairing the meter using the Bezel Repair Kit, be sure to use all of the new parts. To replace the parts do the following.

CAUTION

Be sure to use the disposable grounding wrist strap included with the repair kit. Static electricity can damage the electrical components as the meter is repaired.

1. Relieve the Pressure.

⚠ WARNING



To reduce the risk of serious injury whenever you are instructed to relieve pressure, always follow the Pressure Relief Procedure on page 8.

2. Remove the battery (11). See **Parts Drawing for the 246008 and 249881 Electronic Meters** on page 32.
3. Slide the rear boot (24) off the hose.
4. Remove the meter from the fluid hose.
5. Remove the impact guard (40) from the meter.
6. With a phillips screwdriver remove the four phillips screws (42) holding the bezel to the cover halves (18 & 19). See FIG. 24.
7. With a T-10 torx driver remove the remaining eleven screws (12) holding the cover halves together (18 & 19).

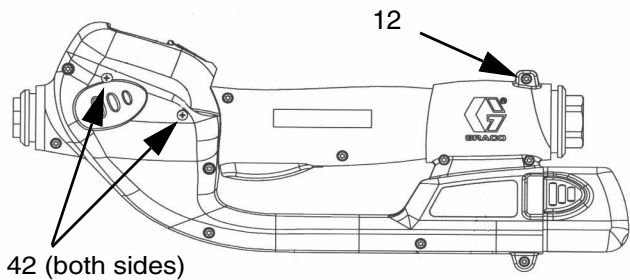



FIG. 24

8. Pull apart the two cover halves leaving all parts in the right cover half (18). See FIG. 25.

 All services to the meter should be done using the right cover half (18) of the meter. If parts should disengage as the covers are separated, reposition the parts back into the right cover half (18).

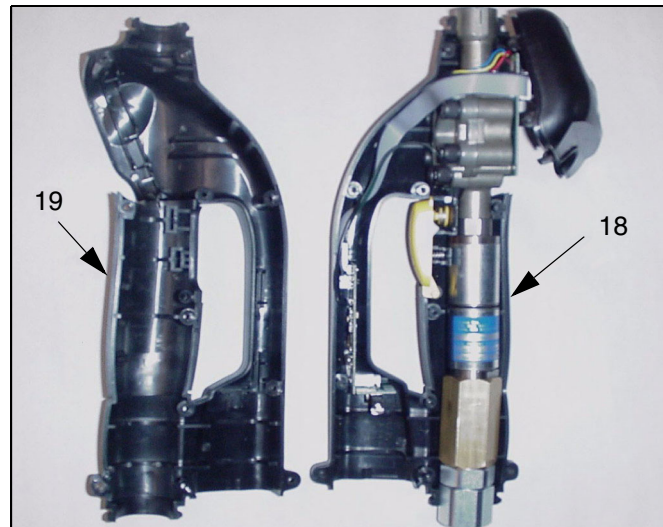

FIG. 25

9. Pull the bezel (31) away and up from the right cover half (18). See FIG. 26.

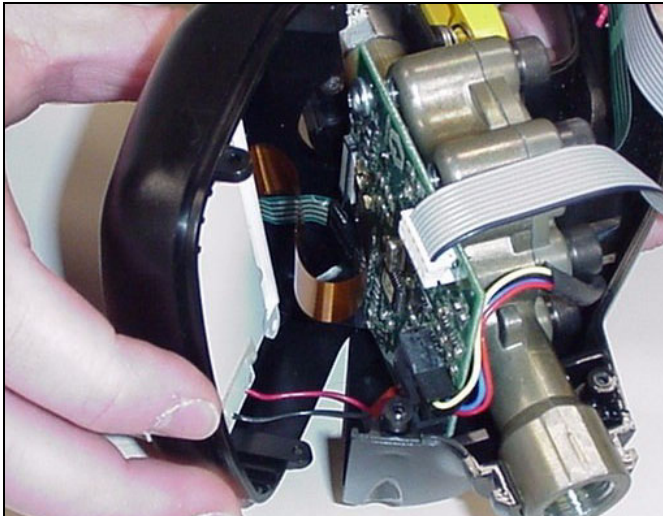

FIG. 26

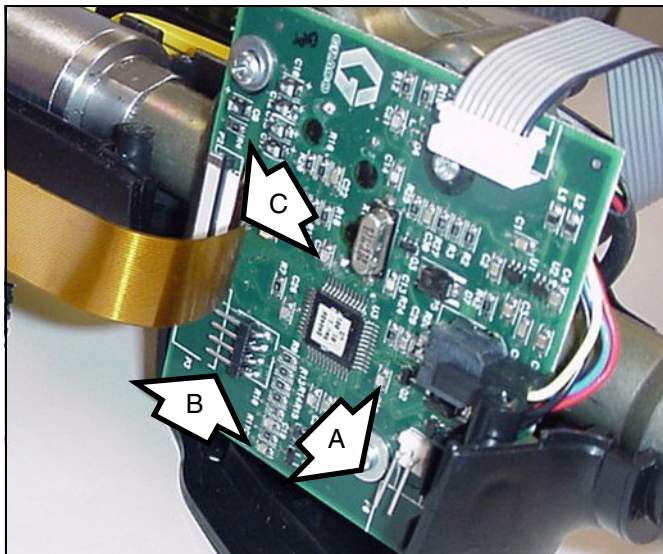



FIG. 27

10. Disconnect the cables/wires (A, B, & C) that connect the bezel (31) to the circuit board (112). Discard the old bezel (31). See FIG. 27 and FIG. 28.
11. Reconnect the cables/wires (A, B, & C) from the new bezel (31) to the circuit board (112).

 When reconnecting cable C to the circuit board (112), ensure that the cable is positioned with the white tab facing up and that the cable is straight before pushing in (closing) the clasp. See FIG. 28.

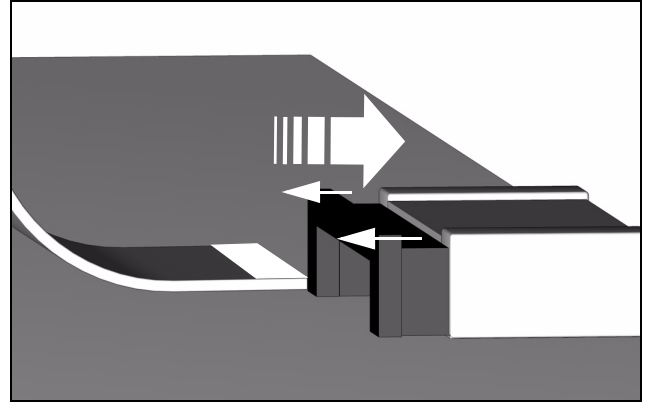



FIG. 28

12. Replace the bezel (31) onto the right meter cover half (18).

 Ensure that all meter parts are positioned securely and in the correct location. Ensure that all cables are routed correctly throughout the meter and will not be pinched or kinked when the halves are reassembled. See FIG. 29 and FIG. 30.

 Ensure that the black antenna wire is not positioned between the ribbon cables. Pull antenna away from the cable as shown. See FIG. 31.

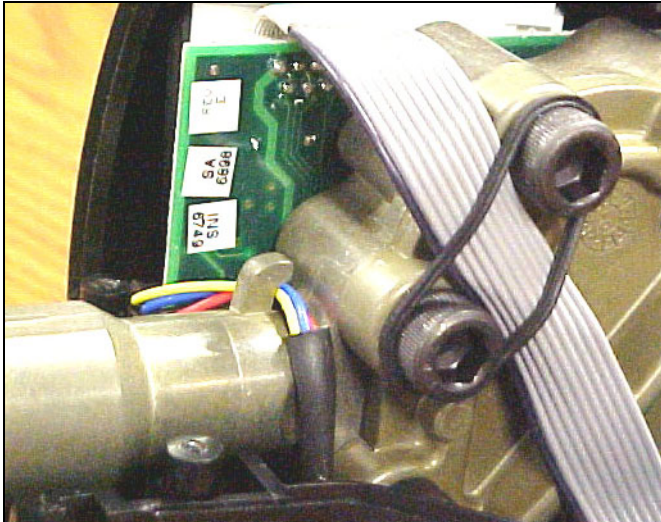

FIG. 29

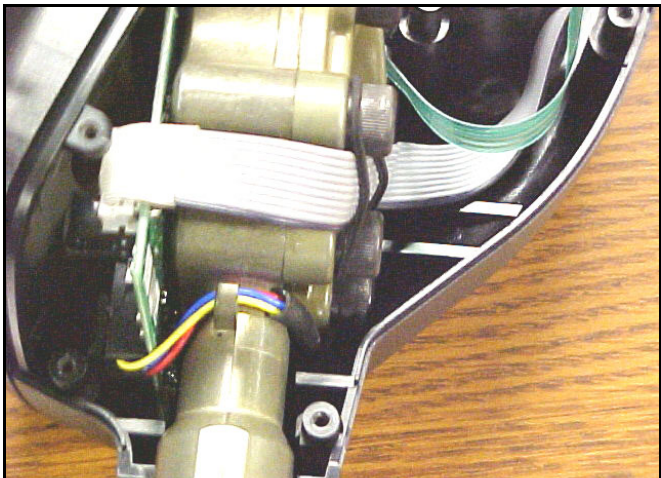

FIG. 30

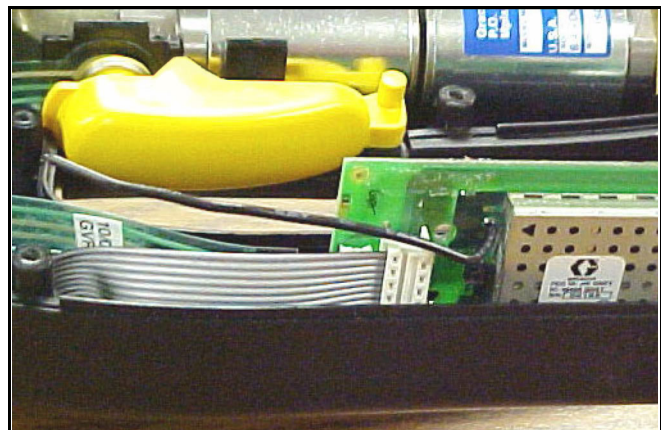

FIG. 31

13. Assemble the covers (18 & 19). Insert several of the screws (12) to temporarily hold the cover halves (18 & 19) together. Test the display by inserting a battery (11) and powering on the unit.

If the display does not appear:

- make sure that a charged battery (11) is being used.
- check that the connections from the new bezel (31) to the circuit board (112) are fastened correctly and securely.
- check that all remaining parts are repositioned securely and in the correct location.

14. If the display appears and is operating correctly, replace the remaining screws (12) and (42) that fasten the cover halves (18 & 19) together. Torque all screws to 7 - 10 in. lbs.

15. Replace the rear boot (24) and impact guard (40).

16. Attach the meter to the fluid line by following steps listed on page 9.

Replacing the Trigger

Trigger Repair Kits 246439 for meter 246008 and 249883 for meter 249881 are available and can be ordered separately. See the **Parts List for the 246008 and 249881 Electronic Meters** on page 33. The parts with a ✓ next to their reference numbers are included in this repair kit.



The PSM switch (101) comes attached to the right meter cover half (18). **Do not remove it** during the meter cover repair procedure.

When repairing the meter using the Trigger Repair Kit, use all of the new parts. To replace the parts do the following.

CAUTION

Be sure to use the disposable grounding wrist strap included with the repair kit. Static electricity can damage the electrical components within the meter as the repair is completed.

1. Relieve the Pressure.

WARNING



To reduce the risk of serious injury whenever you are instructed to relieve pressure, always follow the Pressure Relief Procedure on page 8.

1. Remove the battery (11). See **Parts Drawing for the 246008 and 249881 Electronic Meters** on page 32.
2. Slide the rear boot (24) off the hose.
3. Remove the meter from the fluid hose.
4. Remove the impact guard (40) from the meter.
5. With a phillips screwdriver remove the four phillips screws (42) holding the bezel to the cover halves (18 & 19). See FIG. 32.
6. With a T-10 torx driver remove the remaining eleven screws (12) holding the cover halves together (18 & 19).

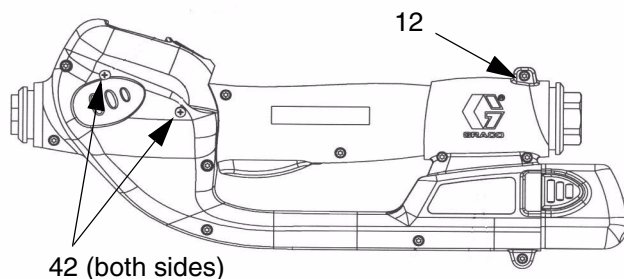



FIG. 32

7. Pull apart the two cover halves leaving all parts in the right cover half (18).

 All services to the meter should be done using the right cover half (18) of the meter. If parts should disengage as the covers are separated, reposition the parts back into the right cover half (18). See FIG. 33.

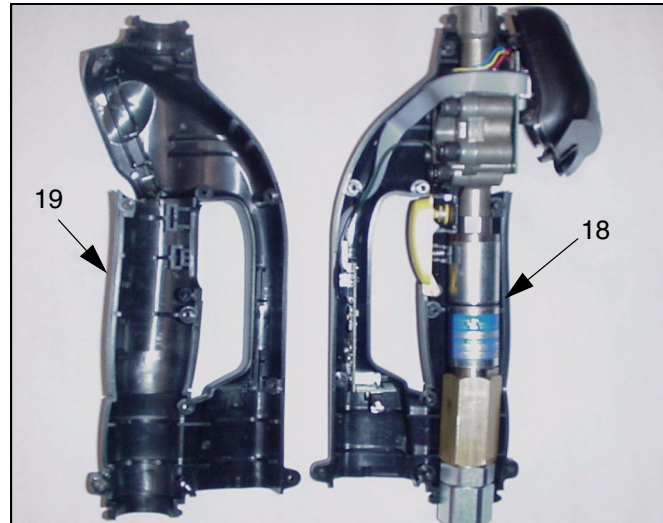



FIG. 33

8. Place the new right cover (18) along side of the meter.
9. Remove the old trigger components (13, 14, 22, 23, 36, & 37) and discard. See **Parts Drawing for the 246008 and 249881 Electronic Meters** on page 32.
10. Remove the RF Board (103) from the right meter housing (18) and disconnect the PSM switch (101) by pulling the cable from the RF Board (103). See FIG. 35.
11. Plug connector end of the new PSM switch (101) into the new RF Board (103) connector.
12. Transfer all remaining parts from the old meter cover half (18) to the new meter cover half (18). Discard the old meter cover halves (18) and (19).
13.  The two ribs (E) of the new meter cover fit between the two bolts (F) of the meter housing. Be sure not to pinch or crimp the circular switch cable (D) on the new cover half. See FIG. 34.

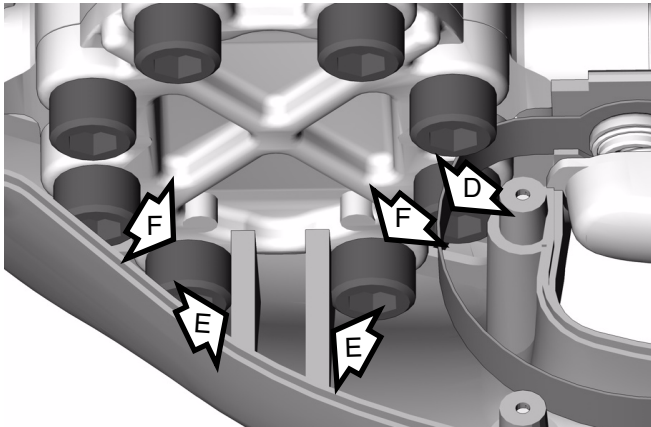



FIG. 34

14. Insert the RF Board (103) into the new right meter half (18). See FIG. 35.

 Ensure that the RF Board (103) is positioned securely in the slots (A) of the new right meter half (18). See FIG. 35.

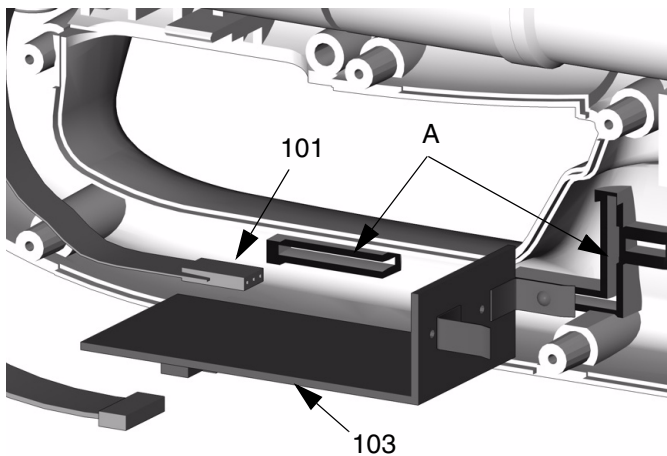



FIG. 35

15. Slide the trigger assembly (13, 14, 22, 23, 36, & 37) back onto the mounting peg on the right half of the meter (18). See FIG. 36.

 Ensure that the circular trigger plunger (23) is centered with the trigger switch. Also ensure that the trigger spring (37) is securely slid into position. See FIG. 36.

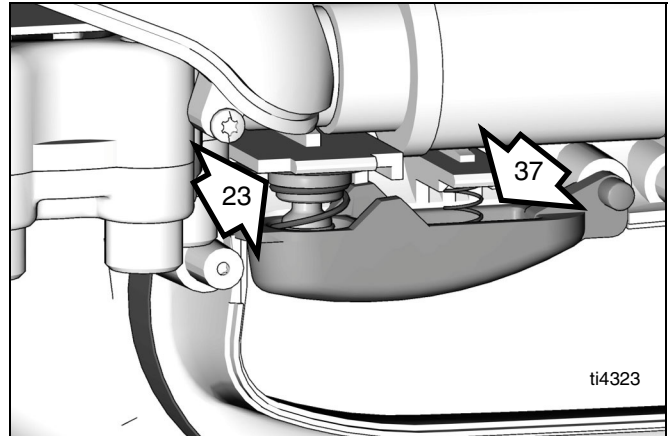

FIG. 36

16. Make sure that all other meter parts are positioned securely and in the correct location. See FIG. 37.

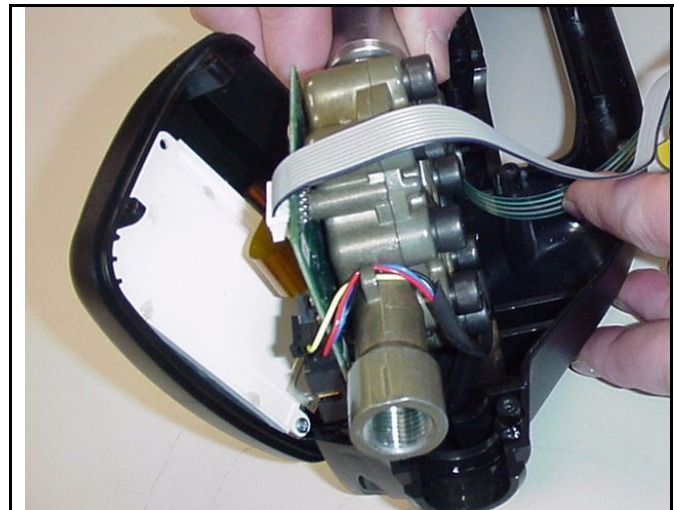



FIG. 37

17. Attach the bezel (31) to the right meter housing (18).

 Ensure that all meter parts are positioned securely and in the correct location. Ensure that all cables are routed correctly throughout the meter and will not be pinched or kinked when the halves are reassembled. See FIG. 38 and FIG. 39.

 Ensure that the black antenna wire is not positioned between the ribbon cables. Pull antenna away from the cable as shown. See FIG. 40.

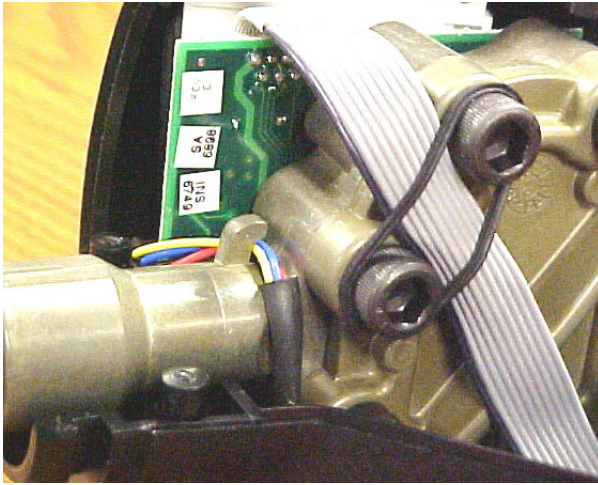

FIG. 38

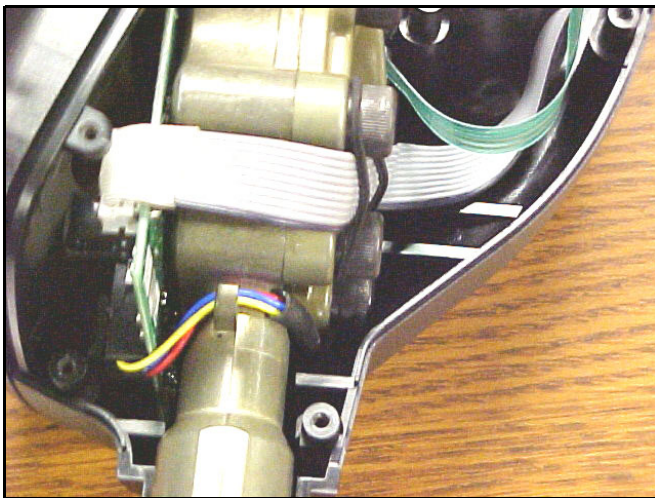

FIG. 39

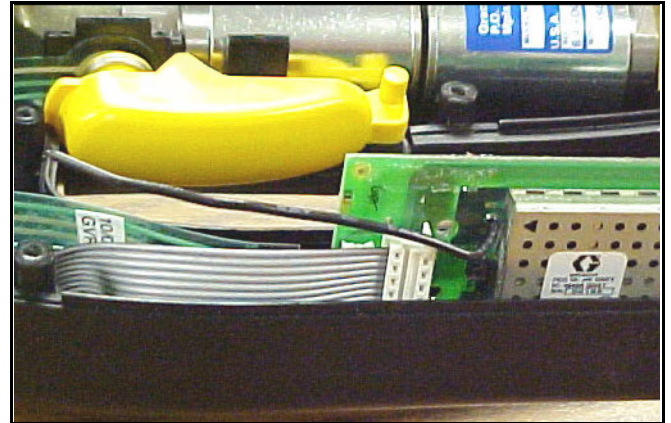

FIG. 40

18. Assemble the covers (18 & 19). Insert several of the screws to hold the cover halves together. Test the display and trigger by inserting a battery and powering on the unit. If display does not appear or trigger does not function:

- make sure that a charged battery (11) is being used.
- check that the connections from the new bezel (31) to the circuit board (112) are fastened correctly and securely.
- check that all parts are repositioned securely and in the correct location.
- check that the trigger connection to the RF board (103) is fastened correctly and securely.
- check that the trigger switch is centered properly and that no gaps have formed between the switch and circular indent.

19. If the display appears, test the trigger to be sure that both dispense settings work correctly. Replace the remaining screws (12) and (42) that hold the cover halves together. Torque all screws to 7 - 10 in. lbs.

Replacing the Meter Electronics

Electronics Repair Kits 246675 for meter 246008 and 249882 for meter 249881 are available for replacing the Matrix meter electronics. See the **Parts List for the 246008 and 249881 Electronic Meters** on page 33. The parts with a † next to their reference numbers are included in the Electronics Repair Kit.

When repairing the meter using the Electronics Repair kit be sure to use all of the new parts. To replace the electronics do the following.

 The PSM switch (101) comes attached to the right meter cover half (18). **Do not remove it** during the meter electronics repair procedure.

CAUTION

Be sure to use the disposable grounding wrist strap included with the repair kit. Static electricity can damage the electrical components within the meter during the repair.

1. Relieve the Pressure.

WARNING



To reduce the risk of serious injury whenever you are instructed to relieve pressure, always follow the Pressure Relief Procedure on page 8.

1. Remove the battery (11). See **Parts Drawing for the 246008 and 249881 Electronic Meters** on page 32.
2. Slide the rear boot (24) off the hose.
3. Remove the meter from the fluid hose.
4. Remove the impact guard (40) from the meter.
5. With a phillips screwdriver remove the four phillips screws (42) holding the bezel to the cover halves (18 & 19). See FIG. 41.
6. With a T-10 torx driver remove the remaining eleven screws (12) holding the cover halves together (18 & 19).

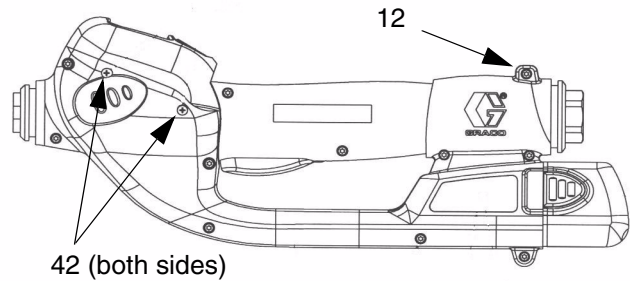



FIG. 41

7. Pull apart the two cover halves leaving all parts in the right cover half (18).

 All services to the meter should be done using the right cover half (18) of the meter. If parts should disengage as the covers are separated, reposition the parts back into the right cover half (18). See FIG. 42.

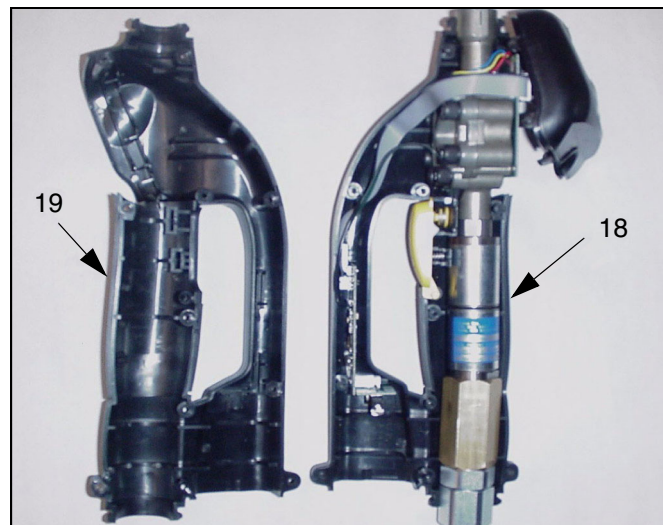

FIG. 42

8. Place the new right cover (18) along side of the meter.
9. Remove the trigger assembly (13, 14, 22, 23, 36, & 37) from the old cover (18) and set aside.
10. Remove the meter housing from the old right cover (18).
11. Disconnect the cables/wires (A, B, C, & D) that connect the bezel (31) to the circuit board (112) and the valve housing to the circuit board. See FIG. 43.

12. Remove the three screws (41) holding the PC Board (112) to the meter housing. See FIG. 43. Note that there is a washer (44) on each screw (41) between the board and the meter housing boss.
13. Remove the RF Board (103) from the cover half and disconnect the PSM switch cable (H) from the RF board (103). Set the old electronics (112, 103) aside. See FIG. 44 and FIG. 46.
14. Connect the new circuit board (112) to the valve housing using three screws (41). See FIG. 43. Be sure to install a washer (44) on each screw (41) between the PC Board and the meter housing boss.

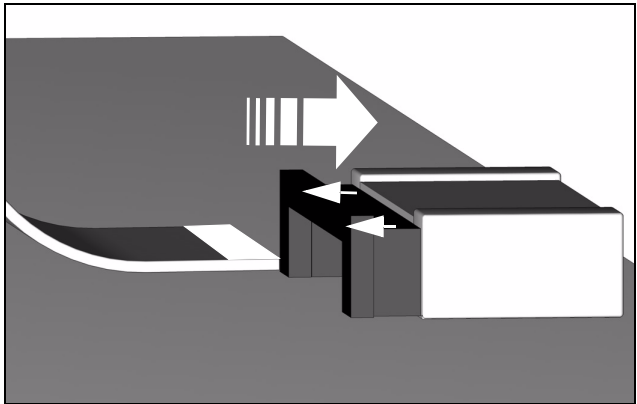

FIG. 44

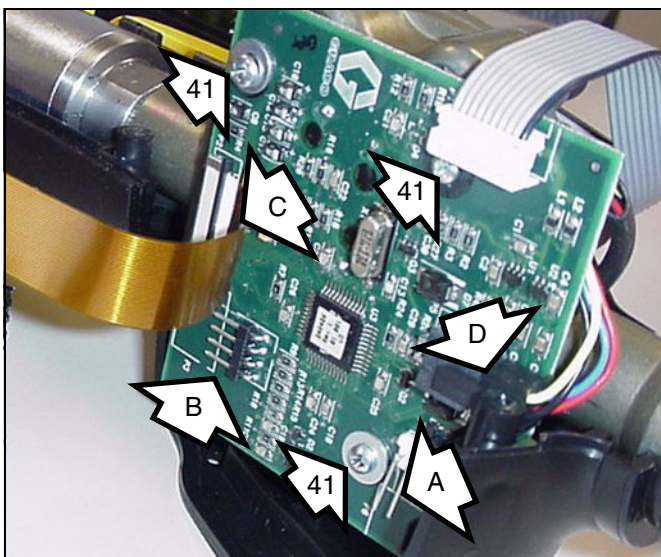





FIG. 43

15. Connect the cables/wires (A, B, C, & D) that connect the bezel (31) and the valve housing to the circuit board (112). See FIG. 43 and FIG. 44.

 When reconnecting cable C to the circuit board (112), ensure that the cable is positioned with the white tab facing up and that the cable is straight before pushing in (closing) the clasp. See FIG. 44.

 When reconnecting cable D be sure that the wires from the valve housing are properly inserted in the valve housing wire retainer hook (G). See FIG. 48.

16. Place the meter housing into the new right cover half (18) being careful not to dislodge the PSM switch (101).

 The two ribs (E) of the new meter cover fit between the two bolts (F) of the meter housing. Be sure not to pinch or crimp the circular switch cable (D) on the new cover half. See FIG. 45.

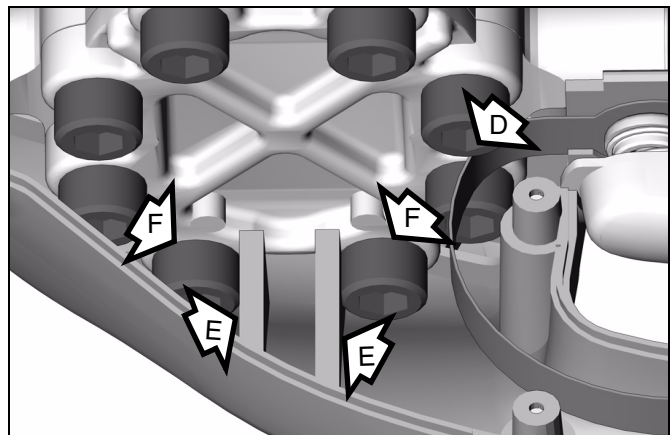

FIG. 45

17. Plug connector end of the new PSM switch (101) into the RF Board (103). See FIG. 46.

18. Insert the RF Board (103) into the meter cover (18). Make sure that the RF board (103) fits securely into the two slots (A). See FIG. 46.

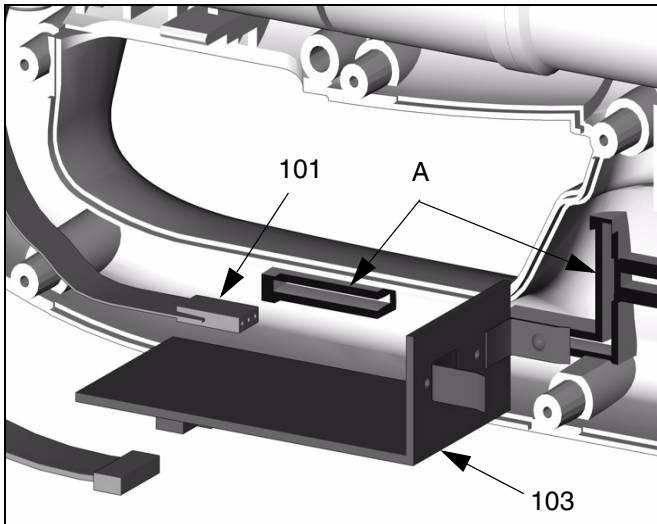



FIG. 46

 Ensure that all meter parts are positioned securely and in the correct location. Ensure that all cables are routed correctly throughout the meter and will not be pinched or kinked when the halves are reassembled. See FIG. 47 and FIG. 48.

 Ensure that the black antenna wire is not positioned between the ribbon cables. Pull antenna away from the cable as shown. See FIG. 49.

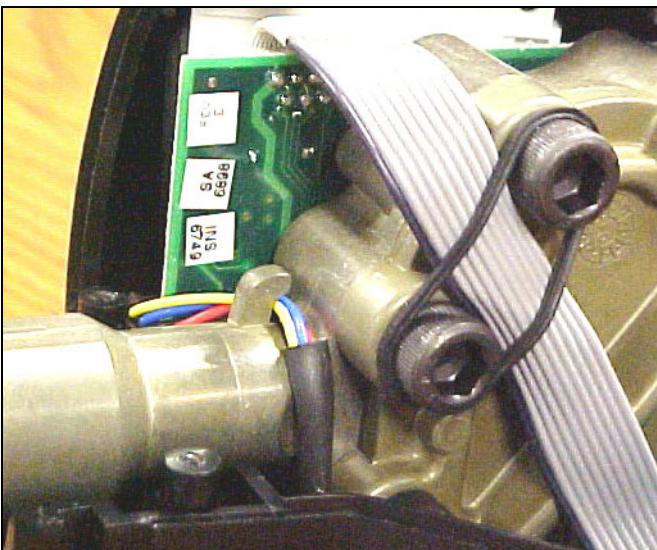

FIG. 47

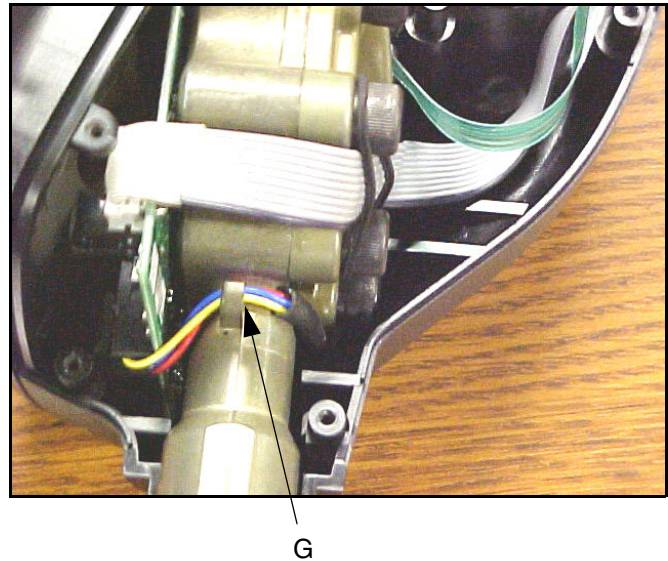

FIG. 48

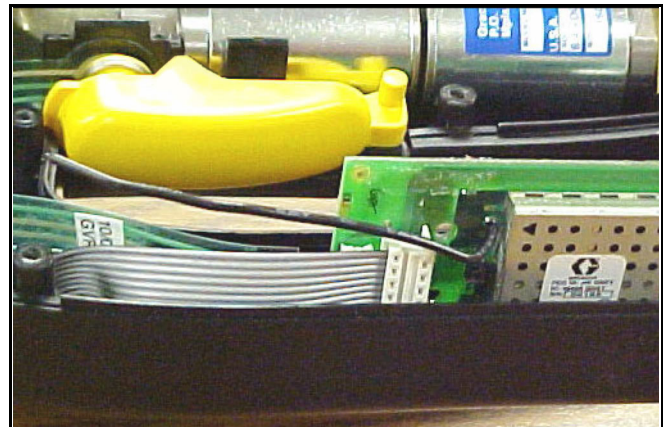



FIG. 49

19. Slide the trigger assembly (13, 14, 22, 23, 35, & 36) onto the mounting peg on the right side of the new meter half (18). See FIG. 36.

 Make sure that the trigger plunger (23) is centered with the circular trigger switch. Also ensure that the trigger spring (37) is slid fully into position. Make sure that all other meter parts are positioned securely and in the correct location. See FIG. 50.

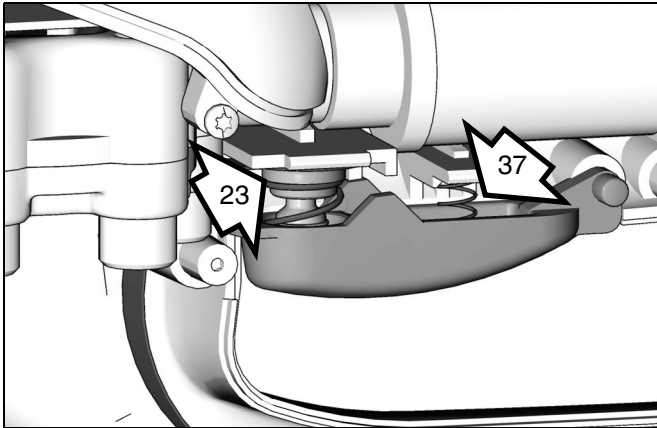
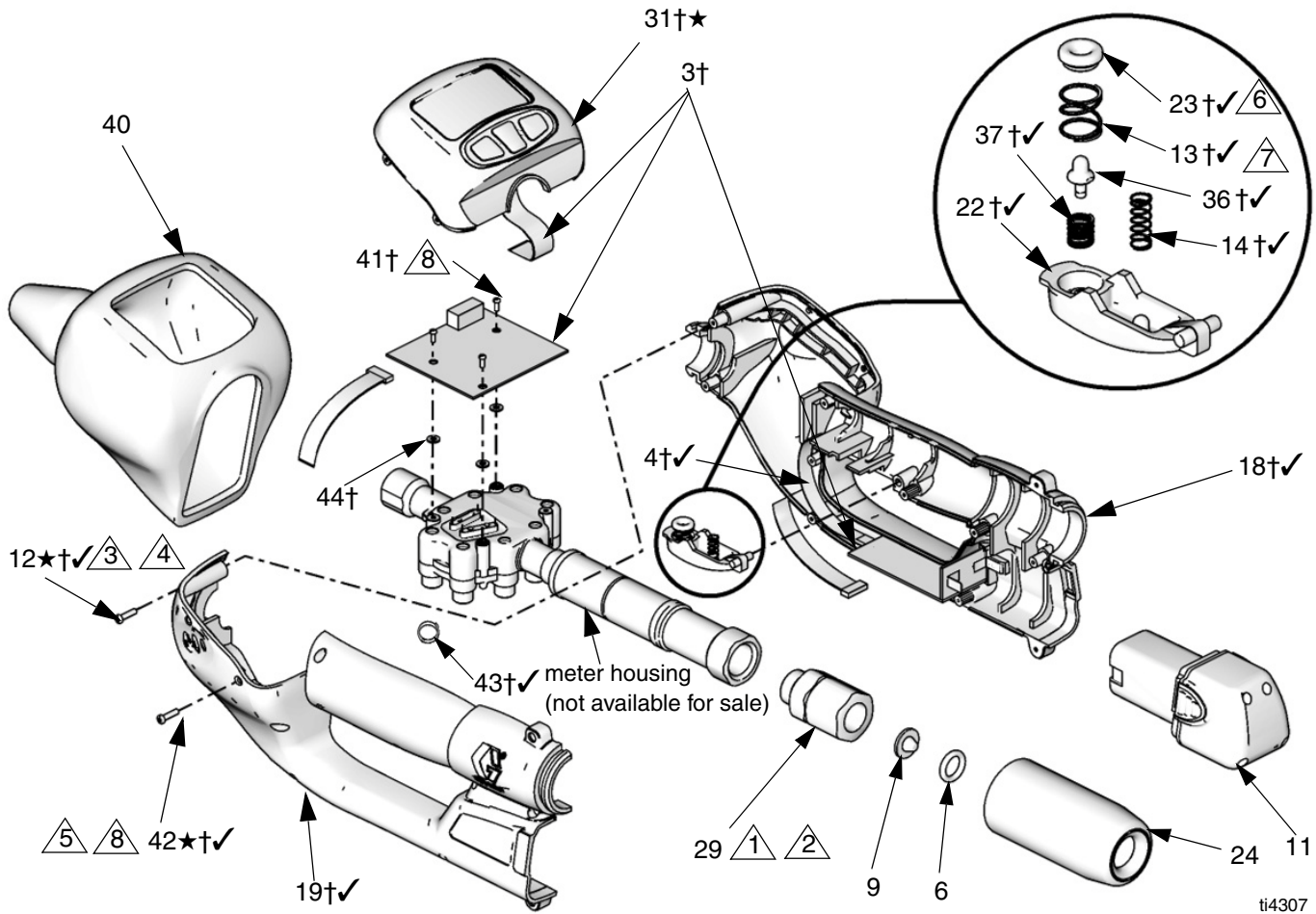

FIG. 50

20. Replace the bezel (31) onto the right meter cover half (18).
21. Assemble the covers (18 & 19). Insert several of the screws (12) to hold the cover halves (18 & 19) together. Test the display and trigger by inserting a battery (11) and powering on the unit. It may take a minute or so before the display starts.
22. If the display appears test the trigger to be sure that both dispense settings work correctly. If the display does not appear or the trigger does not function:
- make sure that a charged battery (11) is being used.
 - check that the connections from the new bezel (31) to the circuit board (41) are fastened correctly and securely.
 - check that all parts are repositioned securely and in the correct location.
 - check that the trigger connection to the RF board (3) is fastened correctly and securely.
 - check that the trigger switch is centered properly and that no gaps have formed between the switch and circular indent.
23. Replace the remaining screws (12) and (42) that hold the cover halves together. Torque all screws to 7 - 10 in. lbs.

Parts Drawing for the 246008 and 249881 Electronic Meters



- 1 torque to 20 - 25 ft. lbs
- 2 apply thread sealant when reassembling
- 3 torque to 7 - 10 in. lbs
- 4 remove screws with a T-10 torx driver
- 5 remove screws with a Phillips screw driver

- 6 plunger must be inserted fully shouldered against the end of the spring.
- 7 spring must be inserted firmly into trigger with a clockwise screwing motion. When fully assembled plunger should sit level with the underside surface of the trigger.
- 8 torque to 3 - 4 in. lbs

Parts List for the 246008 and 249881 Electronic Meters

Ref. No.	Part No.	Description	Qty.	Ref. No.	Part No.	Description	Qty.
3†		MODULE, control, elec	1	24	15D587	BOOT, rear	1
4†✓		SWITCH, PSM, two position	1	29	240416	SWIVEL, straight	1
6	109018	PACKING, o-ring	1	31†★		BEZEL	1
9	114017	FILTER, 80 mesh	1	36†✓		PLUNGER, inside trigger	1
11	117310	BATTERY, 9.6V NMH rechargeable	1	37†✓		SPRING, inside plunger	1
12†★✓		SCREW, mach, torx, 5-20x1/2	11	40†★✓	15D618	GUARD, impact	1
13†✓		SPRING, plunger	1	41†		SCREW, mach, HD, cross	3
14†✓		SPRING, return	1	42†★✓		SCREW, phillips	4
18†✓		COVER, valve right	1	43†✓		RING, quad	1
19†✓		COVER, valve left	1	44†		WASHER	3
22†✓		TRIGGER	1				
23†✓		PLUNGER, trigger	1				



A grounding strap part no. 112190 is included with each of the following kits.

CAUTION

Static electricity can damage the electronic components within the meter if the grounding wrist strap provided is not used during repair kit service.

★ Included in Bezel Repair Kit 246438.

✓ Included in Trigger Repair Kit 246439 for meter 246008 or kit 249883 for meter 249881.

† Included in Electronics Repair Kit 246675 for meter 246008 or kit 249882 for meter 249881.

Nozzle Extension Accessories

Kit 246005

Nozzle Extension Assembly, rigid 45°

Includes:

Ref.	Part No.	Description	Qty.
101	246003	NOZZLE, quick close	1

This same kit is available for antifreeze applications (248319). Antifreeze nozzles are made from brass (gold) instead of steel (silver).

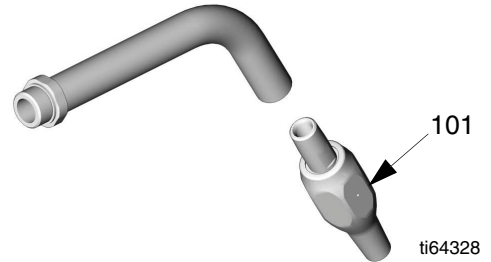

Kit 246006

Nozzle Extension Assembly, rigid, 90°

Includes:

Ref.	Part No.	Description	Qty.
201	246003	NOZZLE, quick close	1

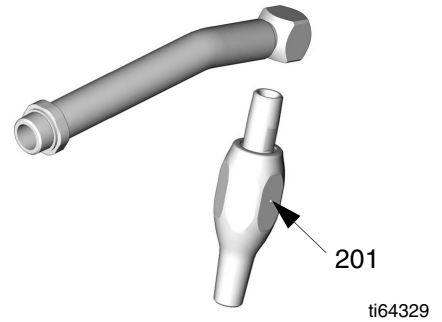

Kit 246007

Nozzle Extension Assembly, flexible hose

Includes:

Ref.	Part No.	Description	Qty.
301	246003	NOZZLE, quick close	1

This same kit is available for antifreeze applications (248320). Antifreeze nozzles are made from brass (gold) instead of steel (silver).

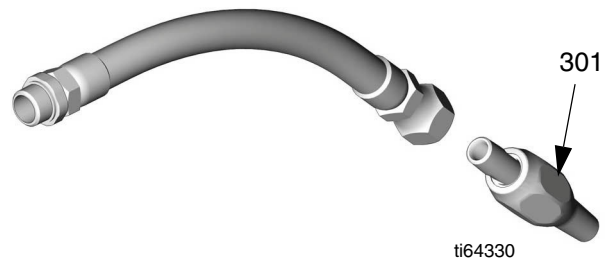

Technical Specifications

Maximum Fluid Working Pressure	1500 psi (10.3 MPa, 103 bar)
Operating pressure range (* ♦)	100 to 1500 psi (0.7 to 10.3 MPa) (7 bar to 103 bar)
Maximum Dynamic Working Pressure (while dispensing) (★)	600 psi (4.1 MPa, 41.4 bar)
Flow Range	0.26 to 5 gpm (1 to 18.9 lpm)
Weight (with battery and rigid nozzle extension)	4.5 lb (2.0 kg)
Units of measurement	user selectable, pints, quarts, gallons or liters
Maximum recorded dispense volume	999.00 units
Maximum preset volume	900.0
Inlet size	1/2" npt(f)
Outlet size	3/8" npt(f)
Operating temperature range	32° F to 120° F (0° C to 49° C)
Storage temperature range	-30° F to 120° F (-34° C to 49° C)
Battery	rechargeable nickel-metal hydride 9.6 VDC
Battery Warranty	6 months
Battery storage temperature range	50° F to 86° F (10° C to 30° C)
Wetted parts	zinc, stainless steel, carbon steel, polyurethane, nitrile rubber
Fluid compatibility	lubricating oils, antifreeze mixtures
Accuracy (†)	+/- 0.5 percent
Repeatability (‡)	+/- 0.15 percent
RF Communication	902-928 MHz frequency hopping, spread-spectrum - N. A. 915-928 MHz frequency hopping, spread-spectrum - Australia
Unobstructed RF Communication Range (based on building construction and RF environment)	300-500 ft. (91.0-152.0 m)
Obstructed RF Communication Range (based on building construction and RF environment)	250-300 ft. (76.2-91.0 m)
Approvals (for RF device contained in meter 246008)	FCC, Industry Canada (IC)
Conformity (for RF device contained in meter 249881)	ACMA (Australia)

* Minimum pressure loss at 1.5 gpm (5.7 lpm) with 30-weight oil at 70° F (21° C) is 70 psi.

† At 2.5 gpm (9.5 lpm), at 70° F (21° C) with 10-weight oil, and 1 gallon dispensed. May require calibration.

‡ At 2.5 gpm (9.5 lpm), at 70° F (21° C) with 10-weight oil, and 1 gallon dispensed.

♦ Specification based on 30W oil. Lighter viscosity fluid (i.e., anti-freeze) will require a slightly higher inlet fluid pressure to open the Matrix valve.

★ Using 30W oil at 70°F (21°C). Maximum pressure will be slightly lower with higher viscosity fluids (i.e., gear oil). A lower ratio pump may be required to reduce system pressure and maintain sufficient flow.



A series of 20 horizontal lines spanning the width of the page, providing a template for handwriting practice. The lines are evenly spaced and extend from the left margin to the right margin.

Dimensions

- A 17.5 in. (444.5 mm) overall length without nozzle dispense kit
- B 4.75 in. (120.6 mm) overall width
- C 5.25 in. (133.3 mm) overall height

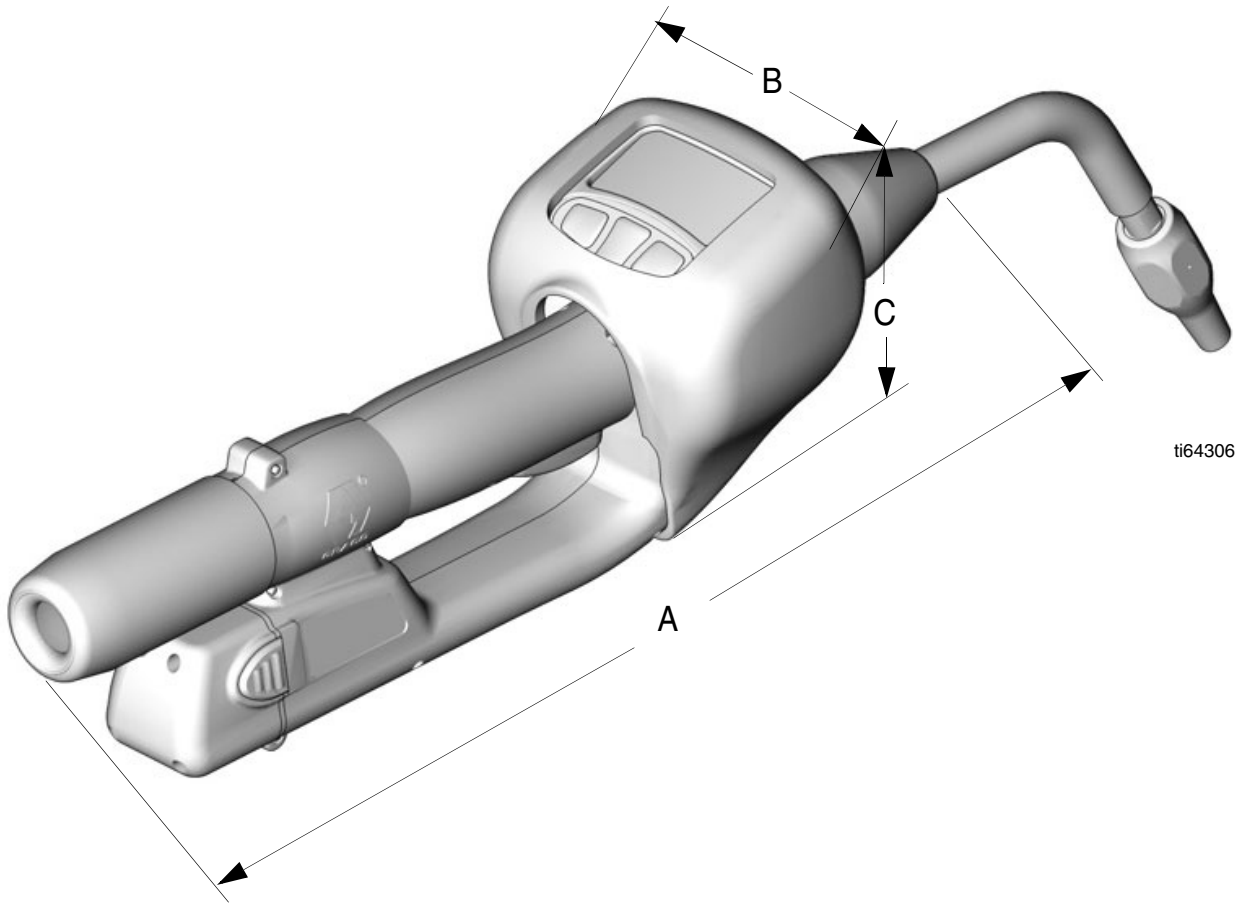

Graco Standard Warranty

Graco warrants all equipment manufactured by Graco and bearing its name to be free from defects in material and workmanship on the date of sale to the original purchaser for use. With the exception of any special, extended, or limited warranty published by Graco, Graco will, for a period of twenty-four months from the date of sale, repair or replace any part of the equipment determined by Graco to be defective *with the exception of the Matrix Meter Battery, part number 117310 which has a warranty period of six months from the date of sale to the original purchaser*. This warranty applies only when the equipment is installed, operated and maintained in accordance with Graco's written recommendations.

This warranty does not cover, and Graco shall not be liable for general wear and tear, or any malfunction, damage or wear caused by faulty installation, misapplication, abrasion, corrosion, inadequate or improper maintenance, negligence, accident, tampering, or substitution of non-Graco component parts. Nor shall Graco be liable for malfunction, damage or wear caused by the incompatibility of Graco equipment with structures, accessories, equipment or materials not supplied by Graco, or the improper design, manufacture, installation, operation or maintenance of structures, accessories, equipment or materials not supplied by Graco.

This warranty is conditioned upon the prepaid return of the equipment claimed to be defective to an authorized Graco distributor for verification of the claimed defect. If the claimed defect is verified, Graco will repair or replace free of charge any defective parts. The equipment will be returned to the original purchaser transportation prepaid. If inspection of the equipment does not disclose any defect in material or workmanship, repairs will be made at a reasonable charge, which charges may include the costs of parts, labor, and transportation.

THIS WARRANTY IS EXCLUSIVE, AND IS IN LIEU OF ANY OTHER WARRANTIES, EXPRESS OR IMPLIED, INCLUDING BUT NOT LIMITED TO WARRANTY OF MERCHANTABILITY OR WARRANTY OF FITNESS FOR A PARTICULAR PURPOSE.

Graco's sole obligation and buyer's sole remedy for any breach of warranty shall be as set forth above. The buyer agrees that no other remedy (including, but not limited to, incidental or consequential damages for lost profits, lost sales, injury to person or property, or any other incidental or consequential loss) shall be available. Any action for breach of warranty must be brought within two (2) years of the date of sale.

Graco makes no warranty, and disclaims all implied warranties of merchantability and fitness for a particular purpose in connection with accessories, equipment, materials or components sold but not manufactured by Graco. These items sold, but not manufactured by Graco (such as electric motors, switches, hose, etc.), are subject to the warranty, if any, of their manufacturer. Graco will provide purchaser with reasonable assistance in making any claim for breach of these warranties.

In no event will Graco be liable for indirect, incidental, special or consequential damages resulting from Graco supplying equipment hereunder, or the furnishing, performance, or use of any products or other goods sold hereto, whether due to a breach of contract, breach of warranty, the negligence of Graco, or otherwise.

FOR GRACO CANADA CUSTOMERS

The parties acknowledge that they have required that the present document, as well as all documents, notices and legal proceedings entered into, given or instituted pursuant hereto or relating directly or indirectly hereto, be drawn up in English. Les parties reconnaissent avoir convenu que la rédaction du présente document sera en Anglais, ainsi que tous documents, avis et procédures judiciaires exécutés, donnés ou intentés à la suite de ou en rapport, directement ou indirectement, avec les procédures concernées.

Graco Phone Numbers

TO PLACE AN ORDER, contact your Graco distributor or call to identify the nearest distributor.

Phone: 612-623-6928 **or Toll Free:** 1-800-533-9655, **Fax:** 612-378-3590

All written and visual data contained in this document reflects the latest product information available at the time of publication. Graco reserves the right to make changes at any time without notice.

For patent information, see www.graco.com/patents.

Original instructions. This manual contains English. MM 309497

Graco Headquarters: Minneapolis
International Offices: Belgium, China, Japan, Korea

GRACO INC. AND SUBSIDIARIES • P.O. BOX 1441 • MINNEAPOLIS MN 55440-1441 • USA

Copyright 2003, Graco Inc. All Graco manufacturing locations are registered to ISO 9001.

www.graco.com
Revised July 2012